

Coaxial Frequency Mixer

ZP-2+

Level 7 (LO Power +7 dBm) 50 to 1000 MHz



BNC version shown
CASE STYLE: GG60

Connectors	Model
BNC	ZP-2+
SMA	ZP-2-S+

Maximum Ratings

Operating Temperature	-55°C to 100°C
Storage Temperature	-55°C to 100°C
RF Power	50mW
IF Current	40mA

Permanent damage may occur if any of these limits are exceeded.

Coaxial Connections

LO	L
RF	R
IF	X

Features

- low conversion loss, 5.85 dB typ.
- wideband, 50 to 1000 MHz
- excellent L-R isolation, 47 dB typ., L-I, 44 dB typ.
- rugged shielded case

Applications

- VHF/UHF
- cellular
- instrumentation

+RoHS Compliant

The +Suffix identifies RoHS Compliance. See our web site for RoHS Compliance methodologies and qualifications

Outline Drawing

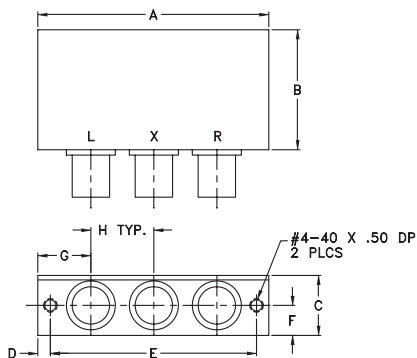

Outline Dimensions (inch/mm)

A	B	C	D	E	F	G	H	wt
2.31	1.20	.60	.125	2.062	.30	.53	.63	grams
58.67	30.48	15.24	3.18	52.37	7.62	13.46	16.00	75.0

Electrical Specifications

FREQUENCY (MHz)	CONVERSION LOSS (dB)	LO-RF ISOLATION (dB)					LO-IF ISOLATION (dB)												
		Mid-Band m		Total Range Max.			L		M		U		L		M		U		
LO/RF f_L-f_U	IF \bar{X} σ Max.	\bar{X}	σ	Max.	Max.	Typ.	Min.	Typ.	Min.	Typ.	Min.	Typ.	Min.	Typ.	Min.	Typ.	Min.	Typ.	Min.
50-1000	DC-1000	5.85	0.10	7.5	9.0	58	40	47	30	42	25	50	35	44	20	29	18		

1 dB COMP.: +1 dBm typ.

L = 50-100 MHz M = 100-500 MHz U = upper range [$f_U/2$ to f_L]
m = mid band [$2f_L$ to $f_U/2$]

Typical Performance Data

Frequency (MHz)	Conversion Loss (dB)	Isolation L-R (dB)	Isolation L-I (dB)	VSWR RF Port (:1)	VSWR LO Port (:1)
50.00	80.00	6.03	61.24	1.08	2.52
100.00	70.00	6.12	55.20	1.10	2.47
129.17	99.17	6.03	53.19	1.12	2.42
200.00	170.00	5.94	49.63	1.17	2.35
208.33	178.33	5.97	49.40	1.22	2.31
287.50	257.50	5.98	46.76	1.27	2.32
340.28	310.28	5.94	45.51	1.33	2.34
366.67	336.67	5.91	45.07	1.36	2.32
445.83	415.83	5.88	43.51	1.43	2.32
498.61	468.61	5.96	42.80	1.47	2.34
500.00	470.00	5.98	42.81	1.50	2.33
551.39	521.39	6.04	42.43	1.58	2.37
630.56	600.56	6.27	41.96	1.68	2.38
683.33	653.33	6.36	41.15	1.76	2.35
709.72	679.72	6.45	40.66	1.79	2.33
788.89	758.89	6.59	39.89	1.94	2.34
868.06	838.06	6.81	39.69	2.11	2.38
947.22	917.22	7.04	39.66	2.31	2.42
973.61	943.61	7.23	39.91	2.37	2.42
1000.00	970.00	7.37	39.73	2.44	2.41

Electrical Schematic

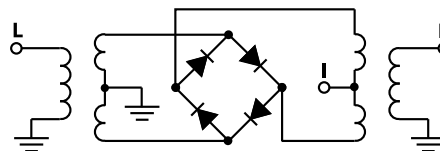

Notes

- Performance and quality attributes and conditions not expressly stated in this specification document are intended to be excluded and do not form a part of this specification document.
- Electrical specifications and performance data contained in this specification document are based on Mini-Circuit's applicable established test performance criteria and measurement instructions.
- The parts covered by this specification document are subject to Mini-Circuits standard limited warranty and terms and conditions (collectively, "Standard Terms"); Purchasers of this part are entitled to the rights and benefits contained therein. For a full statement of the Standard Terms and the exclusive rights and remedies thereunder, please visit Mini-Circuits' website at www.minicircuits.com/MCLStore/terms.jsp



www.minicircuits.com P.O. Box 350166, Brooklyn, NY 11235-0003 (718) 934-4500 sales@minicircuits.com

REV. C
M151107
ZP-2+
DJ/TD/CP/AM
151009
Page 1 of 2

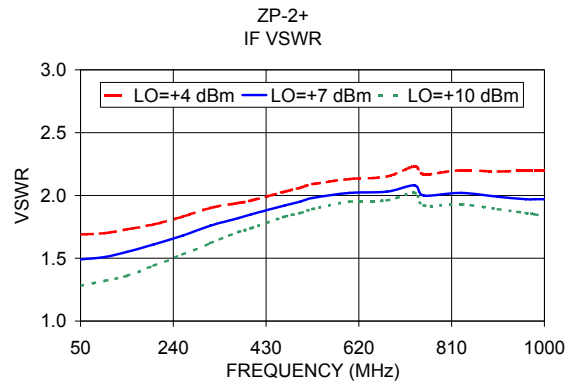
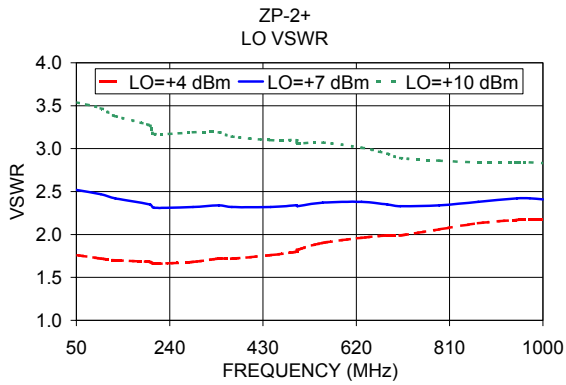
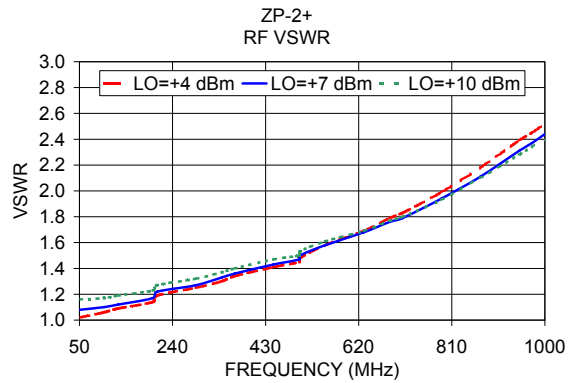
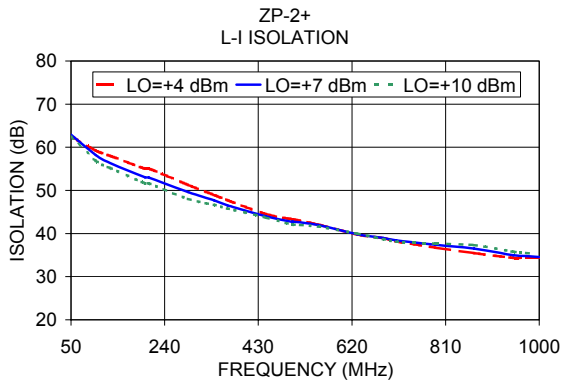
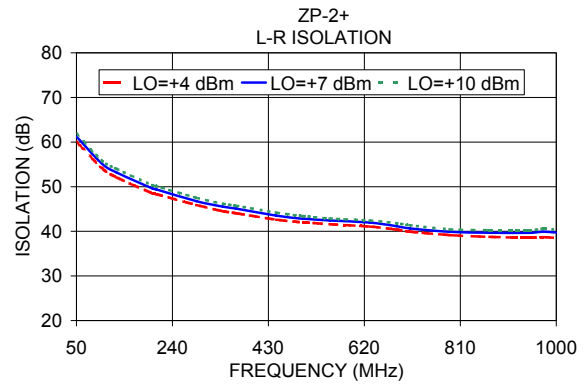
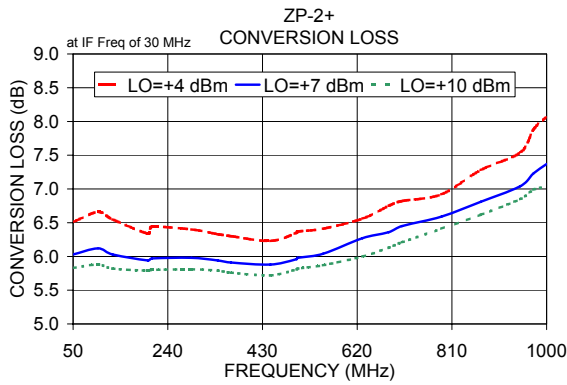

Notes

- A. Performance and quality attributes and conditions not expressly stated in this specification document are intended to be excluded and do not form a part of this specification document.
- B. Electrical specifications and performance data contained in this specification document are based on Mini-Circuit's applicable established test performance criteria and measurement instructions.
- C. The parts covered by this specification document are subject to Mini-Circuits standard limited warranty and terms and conditions (collectively, "Standard Terms"); Purchasers of this part are entitled to the rights and benefits contained therein. For a full statement of the Standard Terms and the exclusive rights and remedies thereunder, please visit Mini-Circuits' website at www.minicircuits.com/MCLStore/terms.jsp

